

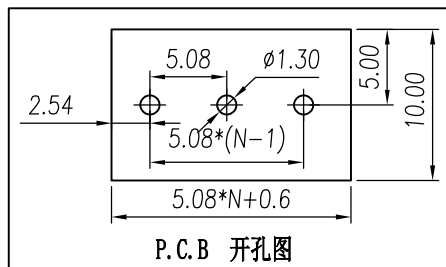

宁波新三和连接电气有限公司

NINGBO NEW SANHE ELECTRIC CONTACT CO., LTD.

产品规格书
THE SPEC SHEET

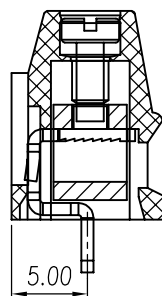
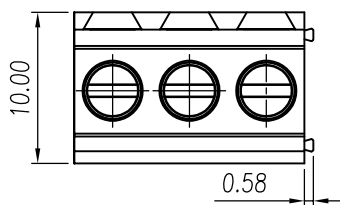
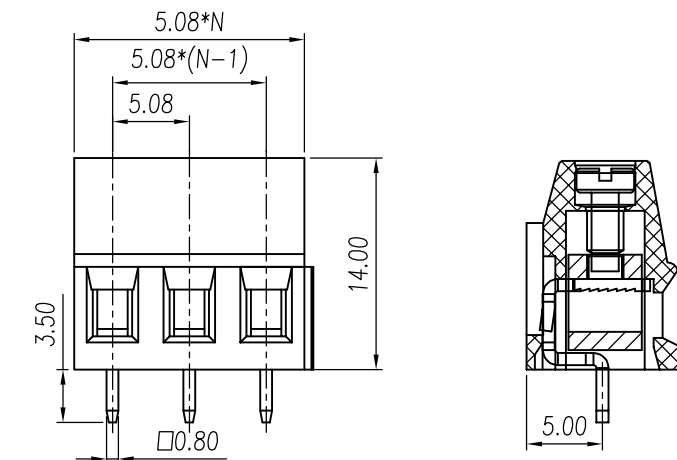

Standard	UL	
	Rated voltage	300V
	Rated current	10A
	Contact resistance	20mΩ
	Insulation resistance	500MΩ/DC500V
	Wrth standing voltage	AC 2000V/1 Min
	Wire range	22~14AWG
Standard	IEC	
	Rated voltage	320V
	Rated current	20A
	Wire range	2.5mm ²
	Temp.Range	-40°C~+105°C
	MAX Soldering	+250°C for 5 Sec
	Torque	0.5Nm
	Steip Length	6-7mm
	Pitch	5.08mm
	Poles	2p,3p

variable range	linear dimension							≡	—	□	//	⊥
	to 10	over 18 to 30	over 30 to 50	over 50 to 80	over 80 to 120	over 120 to 160	over 160 to 200					
tolerance	±0.15	±0.25	±0.35	±0.45	±0.60	±0.75	±0.90	0.5	0.025	0.06	0.12	0.4

产品名称 Product Name	SH142-5.08		
图纸比例 Drawing Scale	2:1	A4	视图 Project View
宁波新三和连接电气有限公司 NINGBO NEW SANHE ELECTRIC CONTACT CO., LTD.		中国宁波慈溪 TEL:+86(574)63226910 FAX:+86(574)63226900	