

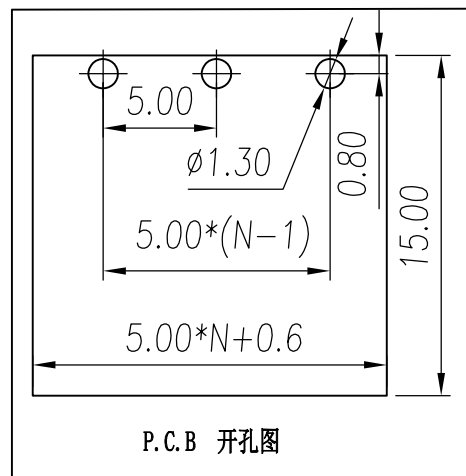

宁波新三和连接电气有限公司

NINGBO NEW SANHE ELECTRIC CONTACT CO., LTD.

产品规格书
THE SPEC SHEET

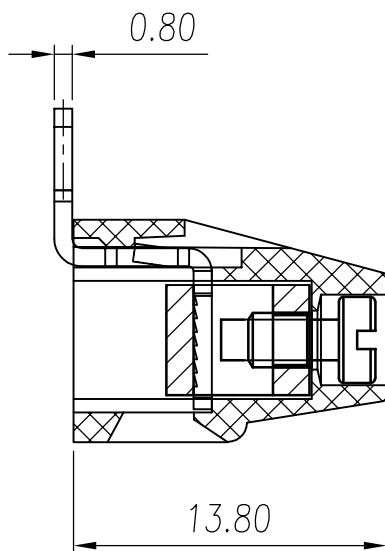
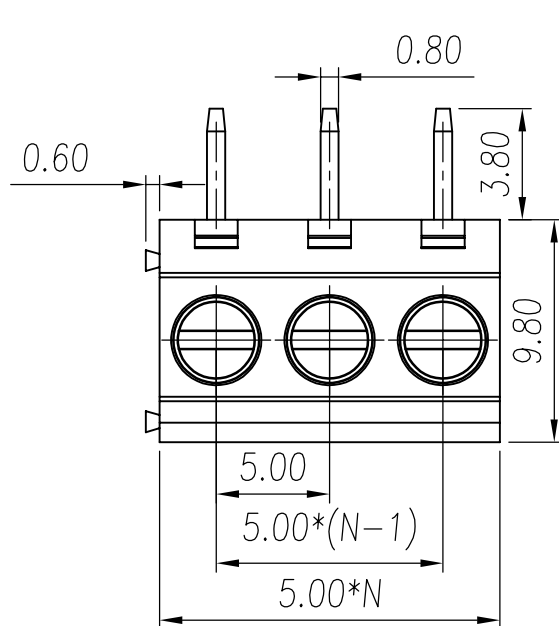

Standard	UL	
Rated voltage		300V
Rated current		10A
Contact resistance		20mΩ
Insulation resistance		500MΩ/DC500V
Wrth standing voltage		AC 2000V/1 Min
Wire range		26~12AWG
Standard	IEC	
Rated voltage		320V
Rated current		20A
Wire range		2.5mm ²
Temp.Range		-40°C~+105°C
MAX Soldering		+250°C for 5 Sec
Torque		0.5Nm
Steip Length		7-8mm
Pitch		5.0mm
Poles		2p,3p

variable range	linear dimension						≡	-	□	//	⊥	
	to 10	over 18 to 30	over 30 to 50	over 50 to 80	over 80 to 120	over 120 to 160						over 160 to 200
tolerance	±0.15	±0.25	±0.35	±0.45	±0.60	±0.75	±0.90	0.5	0.025	0.06	0.12	0.4

产品名称 Product Name	SH136R-5.0		
图纸比例 Drawing Scale	3:1	A4	视图 Project View
宁波新三和连接电气有限公司 NINGBO NEW SANHE ELECTRIC CONTACT CO., LTD.		中国宁波慈溪 TEL: +86(574)63226910 FAX: +86(574)63226900	